



THE ASSAM GAZETTE

অসাধাৰণ

EXTRAORDINARY

প্ৰাপ্ত কৰ্তৃত্বৰ দ্বাৰা প্ৰকাশিত

PUBLISHED BY THE AUTHORITY

নং 154 দিশপুৰ, শনিবাৰ, 5 মাৰ্চ, 2022, 14 ফাগুন 1943 (শক)

No. 154 Dispur, Saturday, 5th March, 2022, 14th Phalguna, 1943 (S. E.)

GOVERNMENT OF ASSAM
ORDERS BY THE GOVERNOR
ASSAM STATE ELECTION COMMISSION

NOTIFICATION

The 3rd March, 2022

No. SEC.17/2022/40.- As per provision of Rule 23 of the Gauhati Municipal Corporation Election, Rules, 1973, the following 'Reserved' and 'Free' symbols are hereby notified to be used by the contesting candidates in the ensuing Guwahati Municipal Corporation Election, 2022. The 'Reserved' symbols should be allowed only if the candidate is sponsored by National/ State Party having the specific symbol already allotted to it by the Election Commission of India.

A. Reserved Symbols for National Parties:

- | | | | |
|----|-------------------------------|---|---|
| 1. | All India Trinamool Congress | - | Flower & Grass |
| 2. | Bahujan Samaj Party | - | Shall select a free symbol as the Symbol 'Elephant' is reserved for AGP by the Election Commission of India |
| 3. | Bharatiya Janata Party | - | Lotus |
| 4. | Communist Party of India | - | Ears of Corn and Sickle |
| 5. | Communist Party of India (M)- | - | Hammer, Sickle and Star |
| 6. | Indian National Congress | - | Hand |
| 7. | Nationalist Congress Party | - | Clock |
| 8. | National People's Party | - | Book |

B. Reserved Symbols for State Parties:

- | | |
|---------------------------------------|------------------------|
| 1. All India United Democratic Front- | Lock & Key |
| 2. Asom Gana Parishad - | Elephant |
| 3. Bodoland Peoples Front - | Nangol |
| 4. United People's Party Liberal - | Tractor Chalata Kishan |

C. Free Symbols: List enclosed at Annexure- I

The allotment of free symbols shall be made in accordance with the Gauhati Municipal Corporation Election Rules, 1973 read with Election Symbols (Reservation and Allotment) Order, 1968 of Election Commission of India (ECI).

Images of the Symbols reserved for National/ State Parties and Free Symbols are enclosed at **Annexure- II and III**.

ALOK KUMAR,
State Election Commissioner, Assam,
Dispur, Guwahati-6.

ANNEXURE- I**(LIST OF FREE SYMBOLS)**





1.	Air Conditioner	43.	Coconut Farm
2.	Almirah	44.	Colour Tray & Brush
3.	Auto- Rickshaw	45.	Computer
4.	Baby Walker	46.	Computer Mouse
5.	Balloon	47.	Cot
6.	Bangles	48.	Crane
7.	Basket containing Fruits	49.	Cube
8.	Bat	50.	Cup & Saucer
9.	Batsman	51.	Cutting Pliers
10.	Battery Torch	52.	Diamond
11.	Bead Necklace	53.	Diesel Pump
12.	Belt	54.	Dish Antenna
13.	Bench	55.	Dolli
14.	Bicycle Pump	56.	Door Bell
15.	Binoculars	57.	Door Handle
16.	Biscuit	58.	Drill Machine
17.	Black Board	59.	Dumbbells
18.	Boat with Man and Sail	60.	Ear Rings
19.	Box	61.	Electric Pole
20.	Bread	62.	Envelope
21.	Bread Toaster	63.	Extension Board
22.	Bricks	64.	Flute
23.	Brief Case	65.	Football Player
24.	Brush	66.	Fountain
25.	Bucket	67.	Frock
26.	Cake	68.	Frying Pan
27.	Calculator	69.	Funnel
28.	Camera	70.	Ganna Kisan
29.	Can	71.	Gas Cylinder
30.	Capsicum	72.	Gas Stove
31.	Carpet	73.	Gift Pack
32.	Carrom Board	74.	Ginger
33.	Cauliflower	75.	Glass Tumbler
34.	CCTV Camera	76.	Gramophone
35.	Chain	77.	Grapes
36.	Chakki	78.	Green Chilli
37.	Chapati Roller	79.	Hand Cart
38.	Chappals	80.	Harmonium
39.	Chess Board	81.	Hat
40.	Chimney	82.	Head Phone
41.	Clip	83.	Helicopter
42.	Coat	84.	Helmet



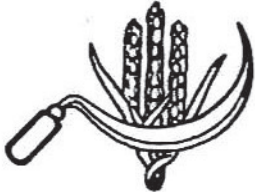

85.	Hockey and Ball	130.	Ring
86.	Hour Glass	131.	Road Roller
87.	Ice Cream	132.	Robot
88.	Immersion Rod	133.	Room Cooler
89.	Iron	134.	Room Heater
90.	Jackfruit	135.	Rubber Stamp
91.	Kitchen Sink	136.	Safety Pin
92.	Lady Finger	137.	Saw
93.	Laptop	138.	School Bag
94.	Latch	139.	Scissors
95.	Letter Box	140.	Sewing Machine
96.	Lighter	141.	Ship
97.	Ludo	142.	Shoe
98.	Lunch Box	143.	Shutter
99.	Man Blowing Turha	144.	Sitar
100.	Matchbox	145.	Skipping Rope
101.	Mike	146.	Slate
102.	Mixee	147.	Soap Dish
103.	Nail Cutter	148.	Socks
104.	Neck Tie	149.	Sofa
105.	Noodles Bowl	150.	Spanner
106.	Pan	151.	Stapler
107.	Pants	152.	Stethoscope
108.	Peanuts	153.	Stool
109.	Pears	154.	Stumps
110.	Peas	155.	Swing
111.	Pen Drive	156.	Switchboard
112.	Pen Nib with Seven Rays	157.	Syringe
113.	Pen Stand	158.	T.V. Remote
114.	Pencil Box	159.	Table
115.	Pencil Sharpener	160.	Tea Filter
116.	Pendulum	161.	Telephone
117.	Pestle and Mortar	162.	Television
118.	Petrol Pump	163.	Tennis Racket & Ball
119.	Phone Charger	164.	Tent
120.	Pillow	165.	Throwing a Javelin
121.	Pineapple	166.	Tiller
122.	Plastering Trowel	167.	Toffees
123.	Plate Containing Food	168.	Tongs
124.	Plate Stand	169.	Tooth Brush
125.	Pot	170.	Tooth Paste
126.	Pressure Cooker	171.	Tray
127.	Punching Machine	172.	Triangle
128.	Razor	173.	Truck
129.	Refrigerator	174.	Trumpet

175.	Tube light	184.	Water Melon
176.	Typewriter	185.	Water Tank
177.	Tyres	186.	Well
178.	Vacuum Cleaner	187.	Wheel Barrow
179.	Violin	188.	Whistle
180.	Walking Stick	189.	Window
181.	Wall Hook	190.	Winnower
182.	Wallet	191.	Wool and Needle
183.	Walnut	192.	Nagrik
		193.	Dustbin



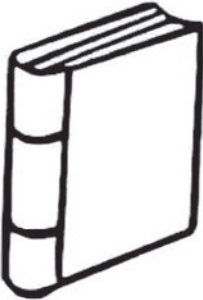

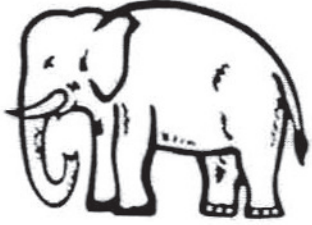
Secretary
Assam State Election Commisison
Dispur :: Guwahati-06



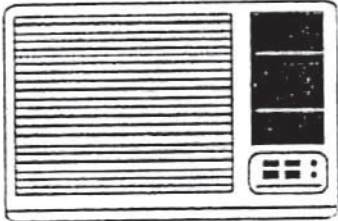

Symbols Reserved for National and State Parties

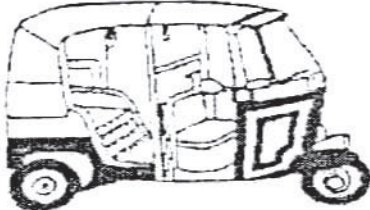

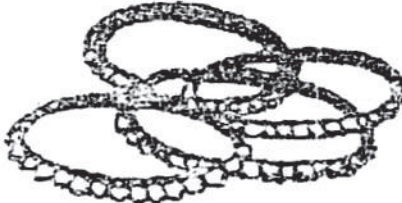

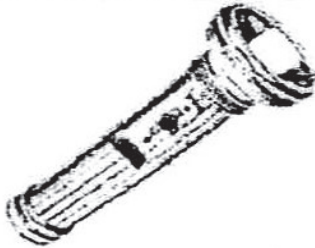

Sl. No.	Name of Political Party	Symbol
1.	All India Trinamool Congress	 <p>Flower & Grass</p>
2.	Bahujan Samaj Party	Shall select a free symbol as the Symbol Elephant is reserved for AGP by the Election Commission of India
3.	Bharatiya Janata Party	 <p>Lotus</p>
4.	Communist Party of India	 <p>Ears of Corn & Sickle</p>
5.	Communist Party of India (Marxist)	 <p>Hammer, Sickle and Star</p>
6.	Indian National Congress	 <p>Hand</p>

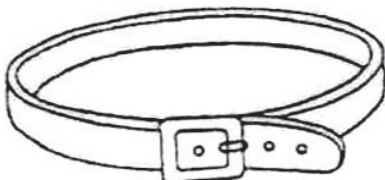
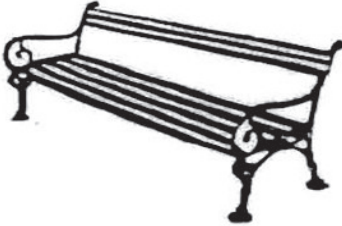

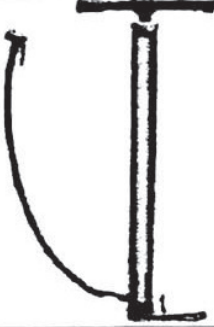
7.	Nationalist Congress Party	 Clock
8.	National People's Party	
9.	All India United Democratic Front	 Lock & Key
10.	Asom Gana Parishad	 Elephant
11	Bodoland Peoples Front	 Nangol
12	United People's Party Liberal	 Tractor Chalata Kishan

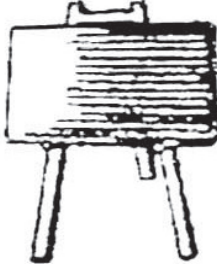

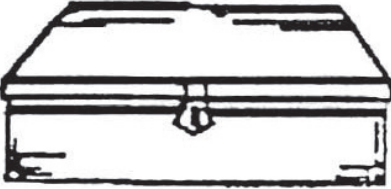

ANNEXURE-III**GMC Election, 2022**
(IMAGES OF FREE SYMBOLS)

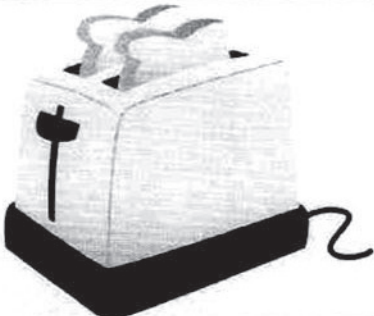
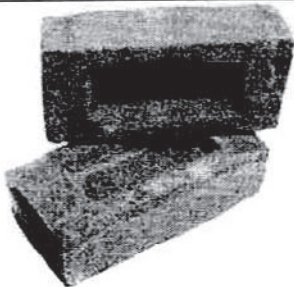
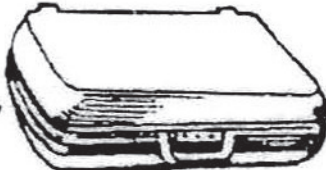
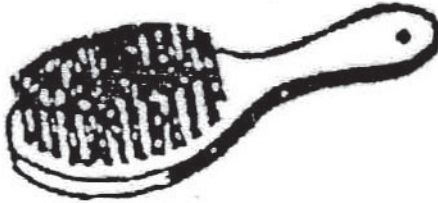

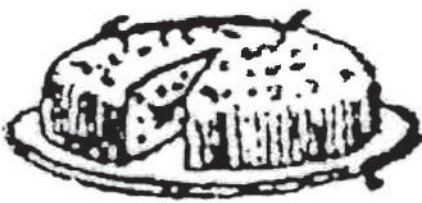

S.No	Symbol	Image
1.	AirConditioner	
2.	Almirah	
3.	Auto- Rickshaw	
4.	Baby Walker	
5.	Balloon	
6.	Bangles	



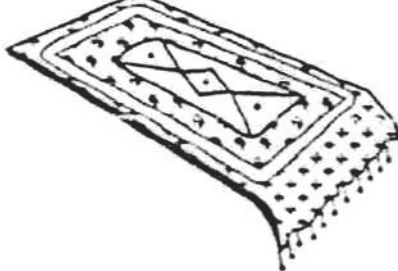
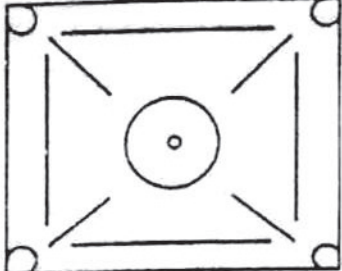

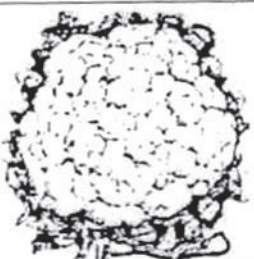
7.	Basket containing Fruits	
8.	Bat	
9.	Batsman	
10.	Battery Torch	
11.	Bead Necklace	
12.	Belt	
13.	Bench	

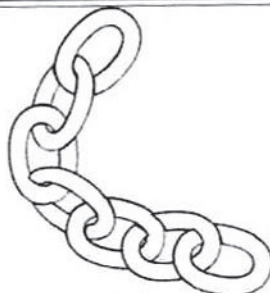
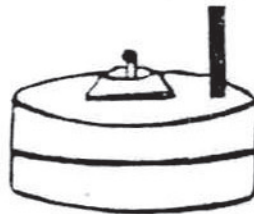
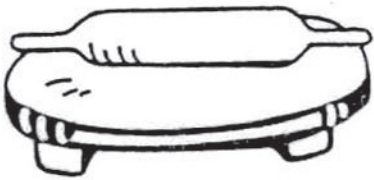



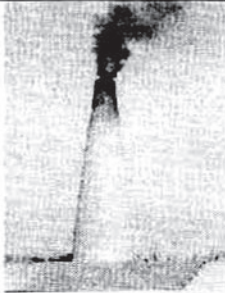

14.	Bicycle Pump	
15.	Binoculars	
16.	Biscuit	
17.	BlackBoard	
18.	Boat with Man and Sail	
19.	Box	
20.	Bread	



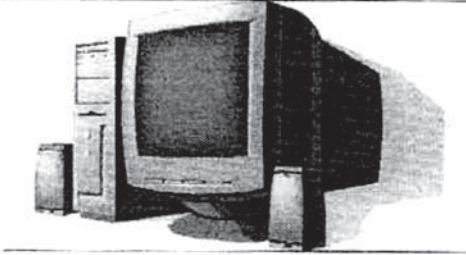

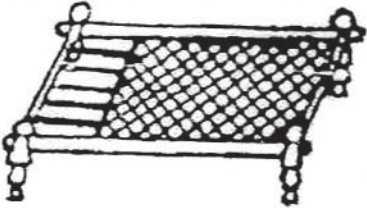
21.	BreadToaster	
22.	Bricks	
23.	BriefCase	
24.	Brush	
25.	Bucket	
26.	Cake	

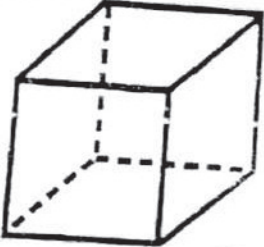

27.	Calculator	
28.	Camera	
29.	Can	
30.	Capsicum	
31.	Carpet	
32.	Carrom Board	

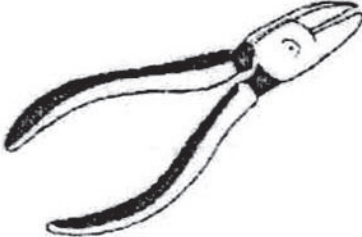
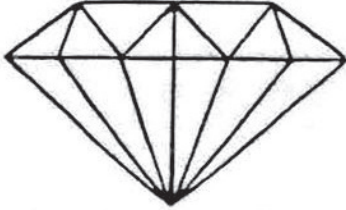
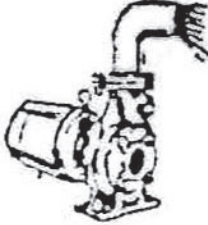

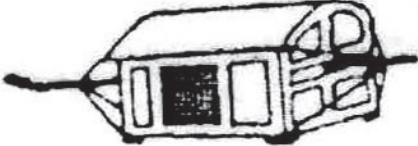

<p>33.</p>	<p>Cauliflower</p>	
<p>34.</p>	<p>CCTV Camera</p>	
<p>35.</p>	<p>Chain</p>	
<p>36.</p>	<p>Chakki</p>	
<p>37.</p>	<p>Chapati Roller</p>	
<p>38.</p>	<p>Chappals</p>	

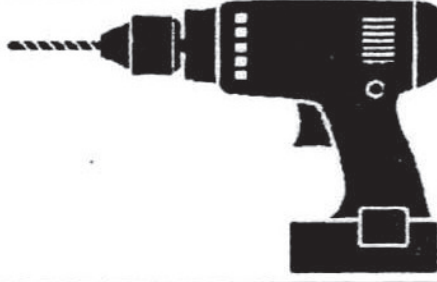
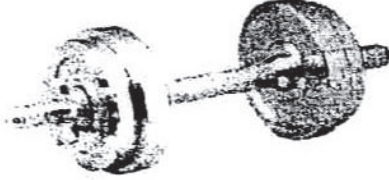

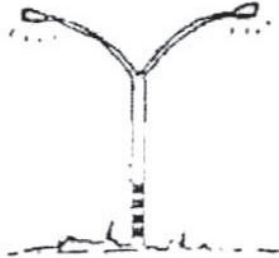
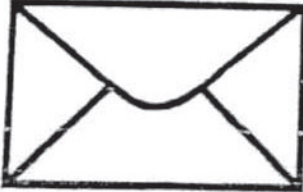

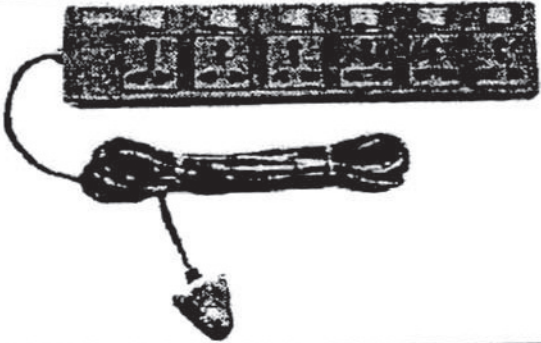
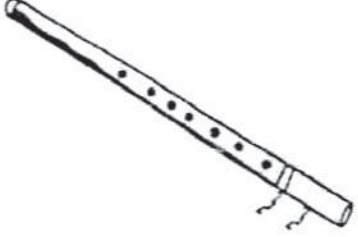
39.	Chess Board	
40.	Chimney	
41.	Clip	
42.	Coat	
43.	Coconut Farm	
44.	Colour Tray & Brush	





45.	Computer	
46.	ComputerMouse	
47.	Cot	
48.	Crane	
49.	Cube	
50.	Cup & Saucer	

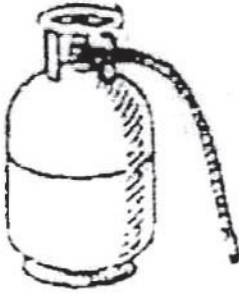
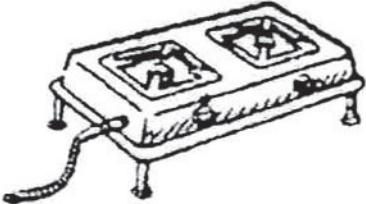



51.	Cutting Pliers	
52.	Diamond	
53.	Diesel Pump	
54.	Dish Antenna	
55.	Dolli	
56.	Door Bell	





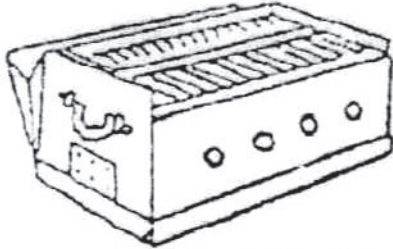

<p>57.</p>	<p>Door Handle</p>	
<p>58.</p>	<p>Drill Machine</p>	
<p>59.</p>	<p>Dumbbells</p>	
<p>60.</p>	<p>Ear Rings</p>	
<p>61</p>	<p>Electric Pole</p>	
<p>62</p>	<p>Envelope</p>	



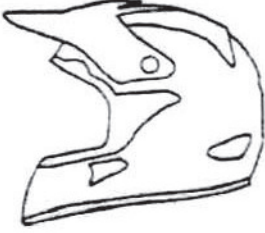

63.	Extension Board	
64.	Flute	
65.	FootballPlayer	
66.	Fountain	
67.	Frock	
68.	Frying Pan	



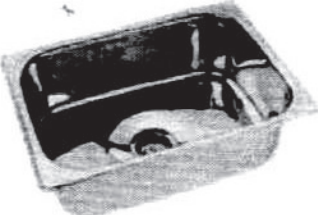

<p>69.</p>	<p>Funnel</p>	
<p>70.</p>	<p>GannaKisan</p>	
<p>71.</p>	<p>Gas Cylinder</p>	
<p>72.</p>	<p>Gas Stove</p>	
<p>73.</p>	<p>Gift Pack</p>	
<p>74.</p>	<p>Ginger</p>	

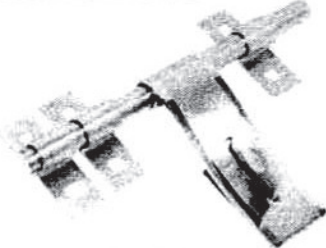



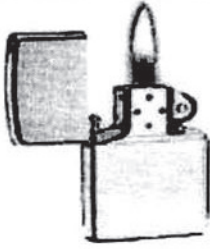
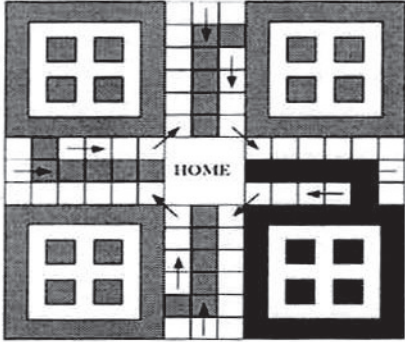

75.	GlassTumbler	
76.	Gramophone	
77.	Grapes	
78.	Green Chilli	



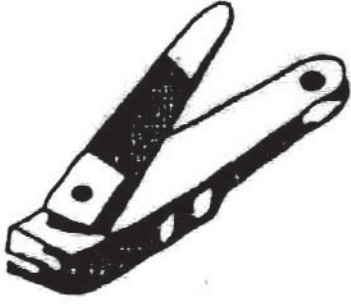

79.	Hand Cart	
80.	Harmonium	
81.	Hat	
82.	Head Phone	
83.	Helicopter	



84.	Helmet	
85.	Hockey and Ball	
86.	Hour Glass	
87.	Ice Cream	
88.	Immersion Rod	
89.	Iron	



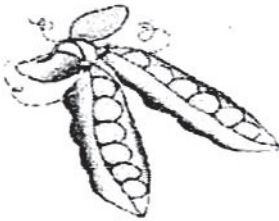
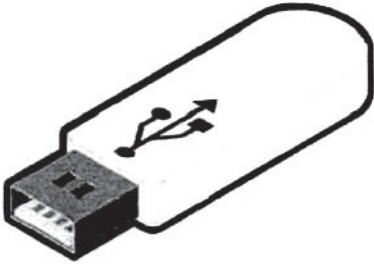

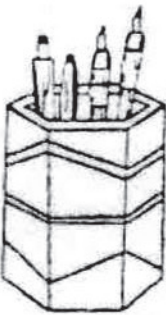
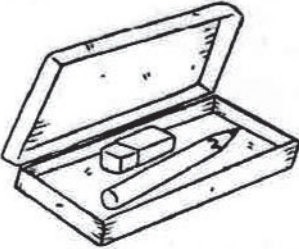
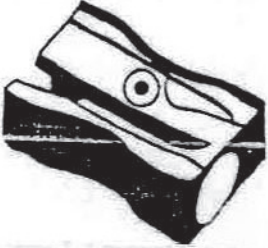
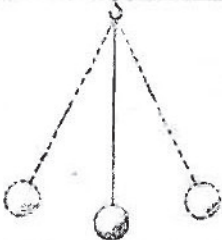

<p>90.</p>	<p>Jackfruit</p>	
<p>91.</p>	<p>Kitchen Sink</p>	
<p>92.</p>	<p>Lady Finger</p>	
<p>93.</p>	<p>Laptop</p>	
<p>94.</p>	<p>Latch</p>	
<p>95.</p>	<p>Letter Box</p>	





96.	Lighter	
97.	Ludo	
98.	Lunch Box	
99.	Man Blowing Turha	
100.	Matchbox	

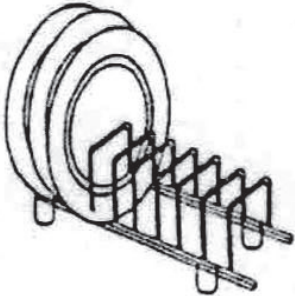



<p>101.</p>	<p>Mike</p>	
<p>102.</p>	<p>Mixee</p>	
<p>103.</p>	<p>Nail Cutter</p>	
<p>104.</p>	<p>Neck Tie</p>	
<p>105.</p>	<p>Noodles Bowl</p>	
<p>106.</p>	<p>Pan</p>	

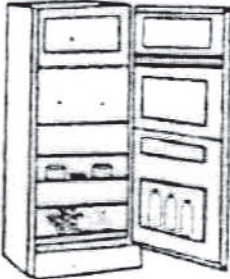

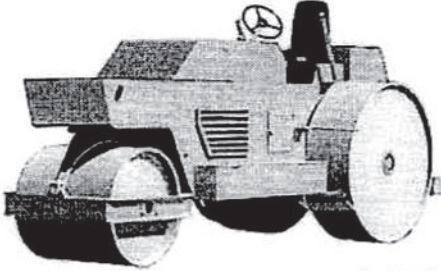
107.	Pants	
108.	Peanuts	
109.	Pears	
110.	Peas	
111.	Pen Drive	
112.	Pen Nib with Seven Rays	



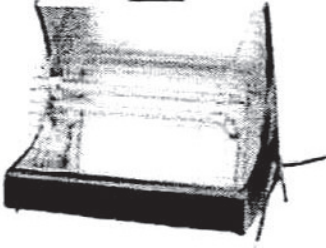
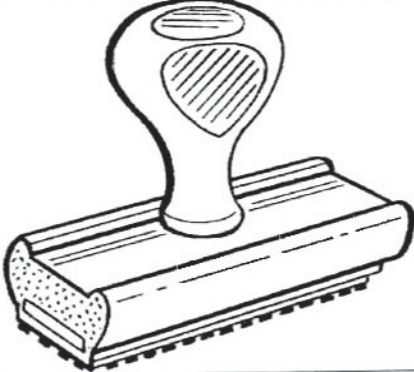

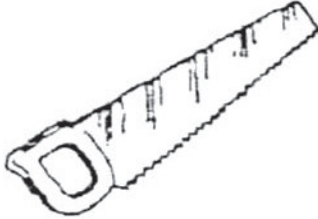
113.	Pen Stand	
114.	Pencil Box	
115.	Pencil Sharpener	
116.	Pendulum	
117.	Pestle and Mortar	
118.	Petrol Pump	

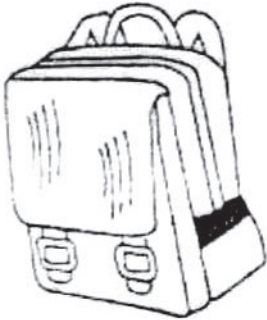
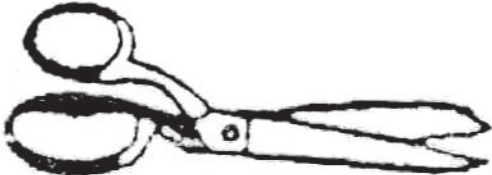
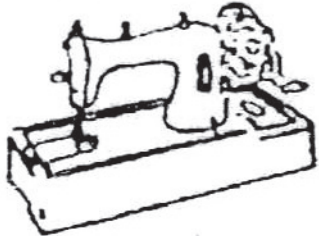
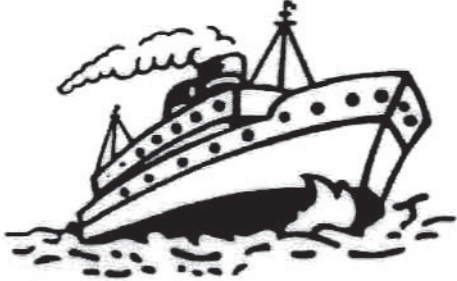

119.	Phone Charger	
120.	Pillow	
121.	Pineapple	
122.	Plastering Trowel	
123.	Plate Containing Food	
124.	Plate Stand	
125.	Pot	

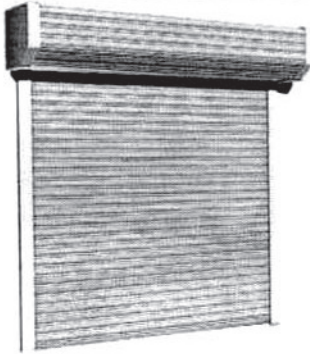

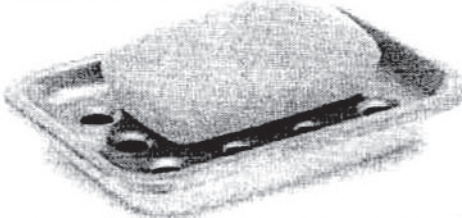

126.	Pressure Cooker	
127.	Punching Machine	
128.	Razor	
129.	Refrigerator	
130.	Ring	
131.	Road Roller	

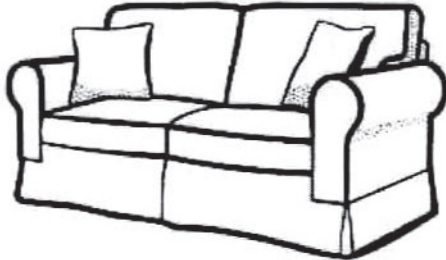
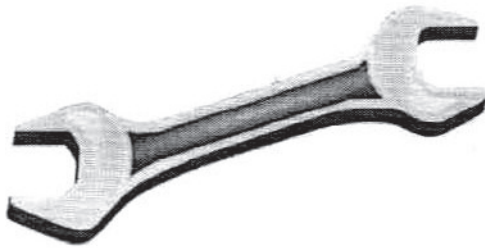
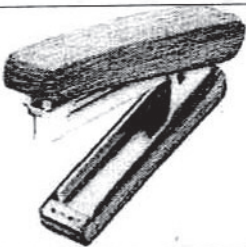

132.	Robot	
133.	Room Cooler	
134.	Room Heater	
135.	Rubber Stamp	
136.	Safety Pin	
137.	Saw	



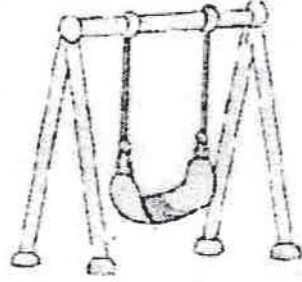
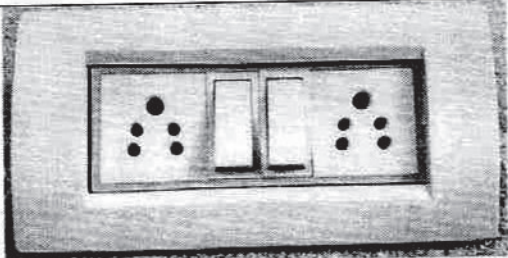

138.	SchoolBag	
139.	Scissors	
140.	Sewing Machine	
141.	Ship	
142.	Shoe	

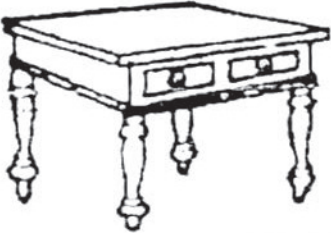
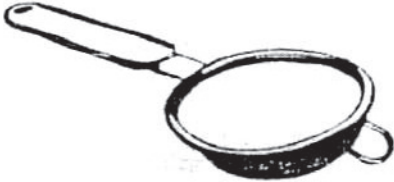

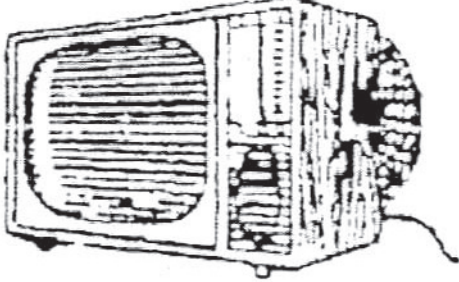
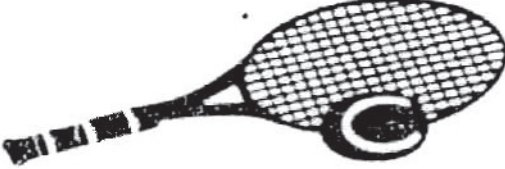
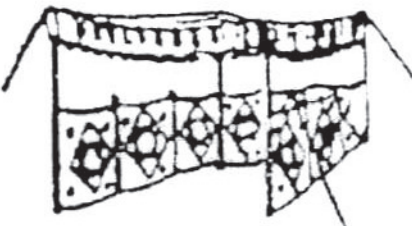
143.	Shutter	
144.	Sitar	
145.	Skipping Rope	
146.	Slate	
147.	Soap Dish	

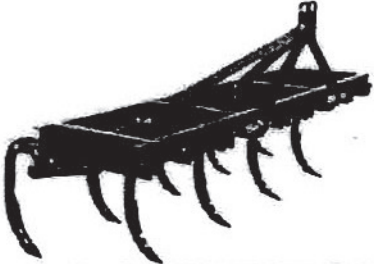

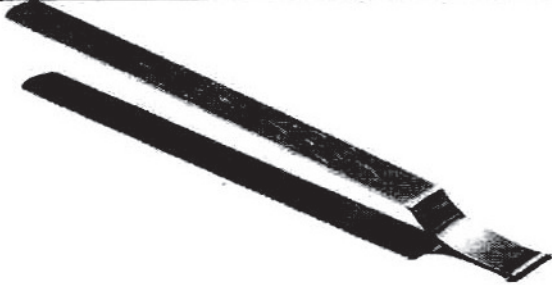

<p>148.</p>	<p>Socks</p>	
<p>149.</p>	<p>Sofa</p>	
<p>150.</p>	<p>Spanner</p>	
<p>151.</p>	<p>Stapler</p>	
<p>152.</p>	<p>Stethoscope</p>	

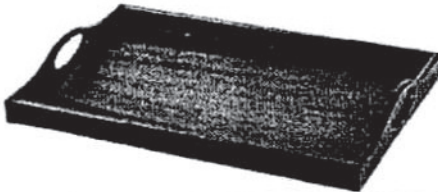
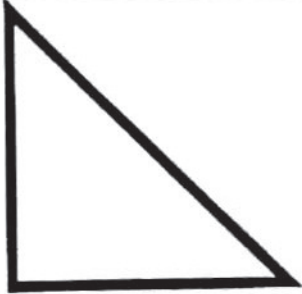

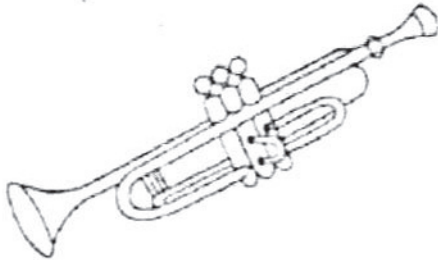
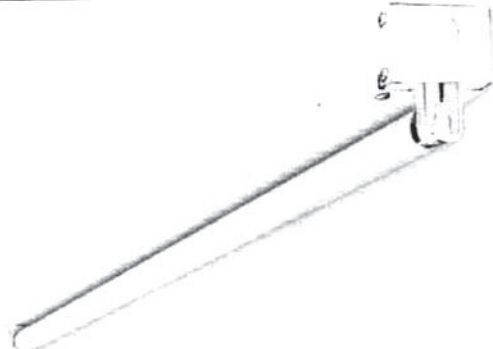
153.	Stool	
154.	Stumps	
155.	Swing	
156.	Switchboard	
157.	Syringe	
158.	T.V.Remote	



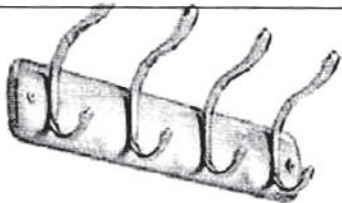
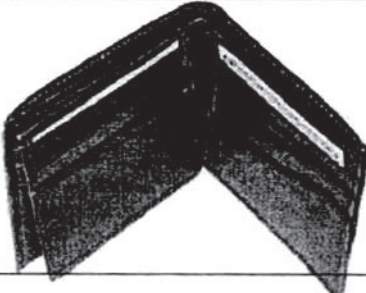

159.	Table	
160.	Tea Filter	
161.	Telephone	
162.	Television	
163.	Tennis Racket & Ball	
164.	Tent	

165.	Throwing a Javelin	
166.	Tiller	
167.	Toffees	
168.	Tongs	
169.	ToothBrush	

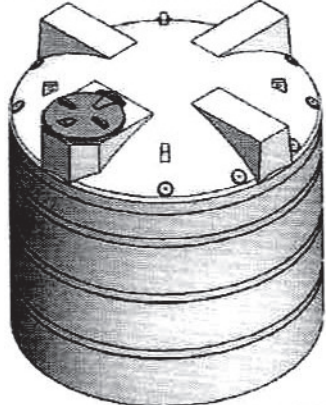
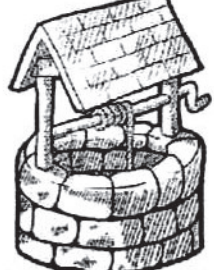
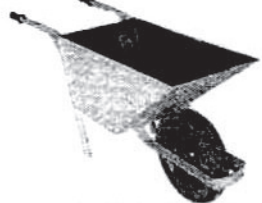
170.	ToothPaste	
171.	Tray	
172.	Triangle	
173.	Truck	
174.	Trumpet	
175.	Tubelight	

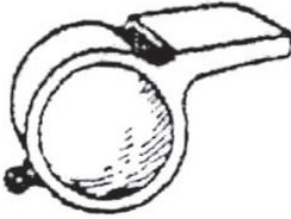
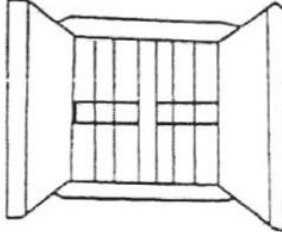
176	Typewriter	
177	Tyres	
178	Vacuum Cleaner	
179	Violin	
180	Walking Stick	
181	WallHook	
182	Wallet	

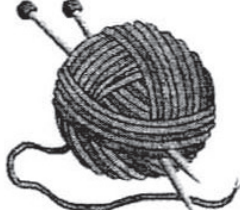
<p>183</p>	<p>Walnut</p>	
<p>184</p>	<p>Water Melon</p>	
<p>185</p>	<p>WaterTank</p>	
<p>186</p>	<p>Well</p>	
<p>187</p>	<p>Wheel Barrow</p>	

188	Whistle	
189	Window	
190	Winnower	
191	Wool and Needle	
192	Nagrik	
193	Dustbin	